

Elbow

Ordering Information

- When ordering, specify material, gauge (if non-standard), dimension and end styles, degree (30°, 45°, 60°, or 90°).
- Elbows in heavier gauges can be supplied in solid welded construction at an additional cost.
- Other CLR's available upon request.

16 Gauge Elbows:

- 16ga Elbows are constructed of gores lapped over one another and spot welded.
- This is a directional elbow supplied with an arrow to indicate the direction of flow. Please specify direction if ordering ends other than QF.
- Interior buffing available with upcharge.
- Galvanized is 16 gauge with 16 gauge collars. SS is 16ga with 20ga collars.

14 Gauge Galvanized Elbows:

- Constructed of butt-welded gores.
- Interior buffing available with upcharge.
- If flanged, vanstone ends with rotational Angle Flanges standard. Welded flanges will be clocked at the centerline as standard.

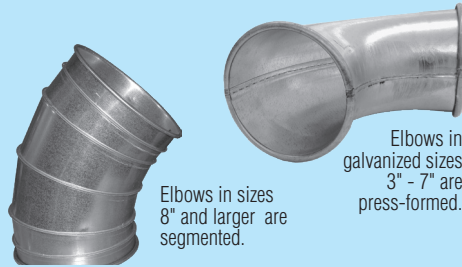

Ø in.	QF Std Weight Lbs	QF 16ga Weight Lbs	QF 14ga Weight Lbs	AFL Std Weight Lbs	AFL 14ga Weight Lbs
3	0.90			1.75	
4	1.00			2.25	
5	1.20			2.80	
6	1.50			3.85	
7	2.20	9.42		4.90	
8	6.10	13.64	19	7.66	23
9	7.60	16.64	24	8.45	29
10	9.00	21.54	29	15.47	35
11	10.50	27.65	35	17.60	41
12	12.40	33.76	42	19.33	49
13	14.26	40.07	46	22.40	54
14	19.00	46.38	50	25.39	59
15	21.25	52.61	54	27.90	69
16	24.00	58.83	59	30.51	75
17	27.50	66.14	63	32.30	80
18	30.90	73.44	68	34.67	85
20	35.97	85.40	97	41.99	110
22	43.06	107.98	103	46.90	124
24	55.50	132.63	131	70.96	154
26				89.12	178
28				99.19	214
30				110.26	233
32				121.38	274
34				133.52	295
36				149.04	340
38				162.31	363
40				176.20	414

QF Material Options

	Galv			SS			
	Gauges	Size (inches)		Gauges	Size (inches)		
		Min. Ø	Max. Ø		Min. Ø	Max. Ø	
Standard	24	3	7	Standard	22	7	12
	22	8	12		20	13	24
	20	13	24		18	8	24
Optional	16	7	24	Optional	16	8	24
	14	8	24				

Degrees	30° 45° 60° 90°	
Diameters CLR's	3" - 7"	1.0**
	8" and larger	1.5

Notes: * 1.0 Galv and 1.5 SS

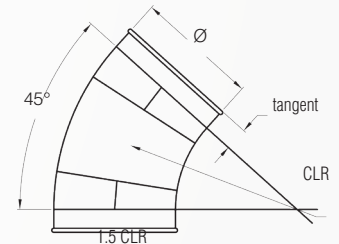

Flanged Material Options

	Galv			SS			
	Gauges	Size (inches)		Gauges	Size (inches)		
		Min. Ø	Max. Ø		Min. Ø	Max. Ø	
Standard	24	3	7	Standard	22	7	12
	22	8	12		20	13	24
	20	13	24		18	26	32
	18	26	32		16	32	40
	16	32	40				
Optional	14	8	50				
	12	10	72				
	10	12	72				

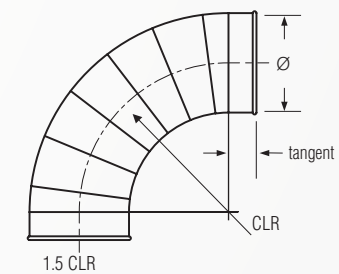

Notes: CLR= Center Line radius

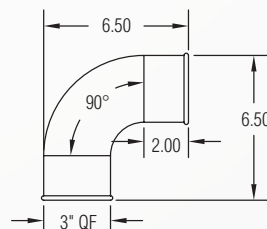

3" 90° Elbow (1.0CLR)

Ø in.	Tangents QF		Tangents AFL	
	Galv	SS	Galv	SS
3	2.00	2.00		
4	1.32	2.00		
5	1.32	2.00	2.00	2.00
6	1.32	2.00		
7	1.32	2.25		
8 to 15	2.00	2.00		
16 to 24	2.00	2.00	4.00	4.00
26 to 40				

Elbow

Construction

3"-7":

Standard galvanized steel 3" to 7" elbows are press formed. Press formed halves are stitch welded together with rolled ends. Stainless steel 3" to 6" elbows are tubed. Press formed halves are stitch welded together with rolled ends.

8" to 24":

8" and larger elbows shown here are gored (segmented) construction with a lock form standing seam every 15°. Gores are spot welded and caulked.

These elbows are produced as follows:

Degree of angle	Number of gores
30°	(1) 15° + (2) 7.5° + (2) tangents
45°	(2) 15° + (2) 7.5° + (2) tangents
60°	(3) 15° + (2) 7.5° + (2) tangents
90°	(5) 15° + (2) 7.5° + (2) tangents

Optional End Styles

Standard QF end can be changed to Raw ID (RI), Raw OD (RO), No Fitting (NF), Hose Adapter (RF), Flat Flange (FFL), Angle Flange (AFL), or Van Stone (VS). Angle Flange (AFL) - Nordfab Angle Flange is industry standard angle flange with pre-drilled holes.

Collars: Collar is located on the exterior side of each port and considered as airflow non-directional. Collars have a laser welded longitudinal seam. If air flow directional product is required, it must be stated on the PO and additional cost may be incurred. A raised lap seam and spot weld are used for attaching the collar to the body and no caulking is used. If caulking is required, additional cost is incurred.

Elbow Long Radius

Ordering Information

- When ordering, specify material, gauge (if non-standard), dimension, end styles, degree (30°, 45°, 60°, or 90°) and note LR (Long Radius).
- Elbows in heavier gauges can be supplied in solid welded construction at an additional cost.
- Other CLR's available upon request.

16 Gauge Elbows:

- 16ga Elbows are constructed of gores lapped over one another and spot welded.
- This is a directional elbow supplied with an arrow to indicate the direction of flow. Please specify direction if ordering ends other than QF.
- Interior buffing available with upcharge.
- Galvanized is 16 gauge with 16 gauge collars. SS is 16ga with 20ga collars.

14 Gauge Galvanized Elbows:

- Constructed of butt-welded gores.
- Interior buffing available with upcharge.
- If flanged, vanstone ends with rotational Angle Flanges standard. Welded flanges will be clocked at the centerline as standard.
- One additional gore is included on each degree style.



Elbows in SS sizes 3" - 6" are Tubed.



Degrees	30°	
	45°	
	60°	
	90°	
Diameters CLR's	3" - 7"	1.5**
	8 - 24"	2.5

Notes: * 1.5 Galv and 2.5 SS

Construction

3"-7":

Standard galvanized steel 3" to 7" elbows are press formed. Press formed halves are stitch welded together with rolled ends.

Stainless steel 3" to 6" elbows are tubed. Press formed halves are stitch welded together with rolled ends.

8" to 24":

8" and larger elbows shown here are gored (segmented) construction with a lock form standing seam every 15°. Gores are spot welded and caulked. See standard radius Elbow above for number of gores.

End Styles

Standard QF end can be changed to Raw ID (RI), Raw OD (RO), No Fitting (NF), Hose Adapter (RF), Flat Flange (FFL), Angle Flange (AFL), or Van Stone (VS). Angle Flange (AFL) - Nordfab Angle Flange is industry standard angle flange with pre-drilled holes.

Collars: Collar is located on the exterior side of each port and considered as airflow non-directional. Collars have a laser welded longitudinal seam. If air flow directional product is required, it must be stated on the PO and additional cost may be incurred. A raised lap seam and spot weld are used for attaching the collar to the body and no caulking is used. If caulking is required, additional cost is incurred.

QF Material Options

Galv				SS			
Gauges	Size (inches)		Gauges	Size (inches)			
	Min. Ø	Max. Ø		Min. Ø	Max. Ø		
Standard	24	3	7	Standard	22	7	12
	22	8	12		20	13	24
	20	13	24		18	8	24
Optional	16	7	24	Optional	16	8	24
	14	8	24				

Flanged Material Options

Galv				SS			
Gauges	Size (inches)		Gauges	Size (inches)			
	Min. Ø	Max. Ø		Min. Ø	Max. Ø		
Standard	24	3	7	Standard	22	7	12
	22	8	12		20	13	24
	20	13	24		18	26	32
	18	26	32		16	32	40
	16	32	40				
Optional	14	8	50				
	12	10	72				
	10	12	72				

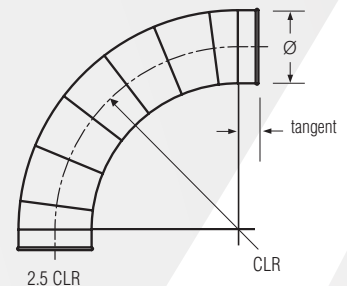

Notes: CLR= Center Line radius
** 7" Ø 16Ga elbow has a 2.5CLR

Elbow Tubed

Ordering Information

- When ordering, specify material, gauge (if non-standard), dimension and degree (30°, 45°, 60°, or 90°).
- Tubed elbows are airflow directional (collar on outside of tube for outlet and collar on inside of tube for inlet).
- Please specify direction if ordering end styles other than QF.



Degrees	30°	45°	60°	90°
Diameters CLR's	3" - 8"	1.5		

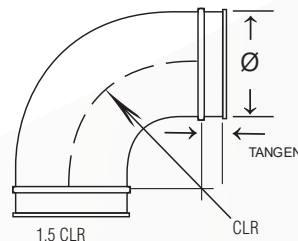

QF Material Options

Galv				SS			
Gauges	Size (inches)		Gauges	Size (inches)		Std	Std
	Min. Ø	Max. Ø		Min. Ø	Max. Ø		
Std	16	3	4	Std	14	3	8
	14	5	8				

Flanged Material Options

Galv				SS			
Gauges	Size (inches)		Gauges	Size (inches)		Std	Std
	Min. Ø	Max. Ø		Min. Ø	Max. Ø		
Std	16	3	4	Std	14	3	8
	14	5	8				

Construction

Standard galvanized steel tube.

Optional End Styles

Standard QF end can be changed to Raw ID (RI), Raw OD (RO), No Fitting (NF), Hose Adapter (RF), Flat Flange (FFL), Angle Flange (AFL), or Van Stone (VS). Nordfab Angle Flange is industry standard angle flange with pre-drilled holes.

Collars: Each end has 2" long collars with one collar on the outside of the tube and another on the inside to make the elbow airflow directional. Please specify direction if ordering varying ends. Collars have a laser welded longitudinal seam. A raised lap seam and spot weld are used for attaching the collar to the body and no caulking is used. If caulking is required, additional cost is incurred.

Elbow Tubed Long Radius

Ordering Information

- When ordering, specify material, gauge (if non-standard), dimension and degree (30°, 45°, 60°, or 90°).
- Tubed elbows are airflow directional (collar on outside of tube for outlet and collar on inside of tube for inlet).
- Please specify direction if ordering end styles other than QF.



Degrees	30°	45°	60°	90°
Diameters CLR's	3" - 8"	2.5		

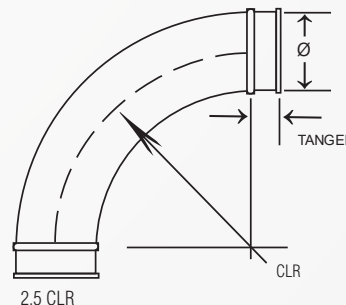

QF Material Options

Galv				SS			
Gauges	Size (inches)		Gauges	Size (inches)		Std	Std
	Min. Ø	Max. Ø		Min. Ø	Max. Ø		
Std	16	3	4	Std	14	3	8
	14	5	8				

Flanged Material Options

Galv				SS			
Gauges	Size (inches)		Gauges	Size (inches)		Std	Std
	Min. Ø	Max. Ø		Min. Ø	Max. Ø		
Std	16	3	4	Std	14	3	8
	14	5	8				

See Elbow Tubed for Construction, End Styles, and Collars information.