

In-Cut

Ordering Information

- When ordering, specify material, gauge (if non-standard), dimensions A and C, C end style, and angle (standard 30°, optional 45°).
- In-cut used to cut into existing lines to begin QF system.

14 Gauge:

- Any Branch with end smaller than 8" will be hybrid. (Smaller section will be a lighter gauge.)

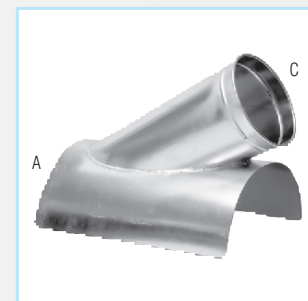

C Ø in.	Weight Lbs
3	1.3
4	1.5
5	2.2
6	2.8
7	3.5
8	4.5
9	5.4
10	6.5
11	7.6
12	8.8
13	11.2
14	13.9
15	15.8
16	17.2
17	19.3
18	21.3
19	23.3
20	25.6
21	27.8
22	30.5
23	33.0
24	35.4
25	37.8
26	40.3
27	42.5
28	45.0
29	50.5
30	56.5
31	59.8
32	63.0
33	63.8
34	67.4
35	69.5
36	71.4
37	73.8
38	76.8
39	79.0
40	81.4

QF Material Options

Galv				SS			
		Size (inches)				Size (inches)	
Gauges		Min. Ø	Max. Ø	Gauges	Min. Ø	Max. Ø	
Standard	22	3	12	Standard	22	3	12
	20	13	24		20	13	24
Optional	18	4	24	Optional	18	8	24
	16	8	24		16	8	24
	14	8	24				

Flanged Material Options

Galv				SS			
		Size (inches)				Size (inches)	
Gauges		Min. Ø	Max. Ø	Gauges	Min. Ø	Max. Ø	
Standard	22	3	12	Standard	22	3	12
	20	13	24		20	13	24
	18	26	30		18	26	30
	16	32	40		16	32	40
	14	42	50		20	4	12
	12	52	72		18	8	24
Optional	20	4	12	Optional	16	8	30
	18	4	24				
	16	8	30				
	14	8	50				
	12	10	72				
	10	12	72				

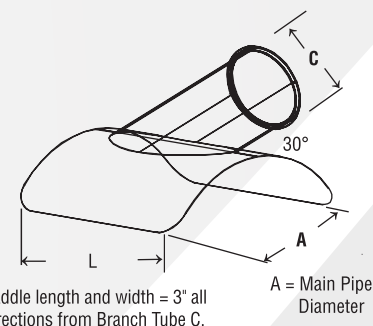

Please carefully note Nordfab In-Cut End Label designations (A and C)

Construction

Seam: Longitudinal seam is lapped, spot welded, and caulked.

Collars: Located on the exterior side of each port and considered as air flow non-directional. Collars have a laser welded longitudinal seam. If airflow directional product is required, it must be stated on the PO and additional cost may be incurred. A raised lap seam and spot weld are used for attaching the collar to the body and no caulking is used. If caulking is required, additional cost may be incurred.

Optional C End Styles

Standard QF end can be changed to Raw ID (RI), Raw OD (RO), No Fitting (NF), Hose Adapter (RF), Flat Flange (FFL), Angle Flange (AFL), or Van Stone (VS).